



USER MANUAL

ENGLISH | FRANÇAIS | DEUTSCH | ESPAÑOL | ITALIANO | РУССКИЙ

NIGHT VISION DIGITAL RIFLESCOPE

DIGEX

N450 | N455

EN Electromagnetic compatibility.
This product complies with the requirements of European standard EN 55032: 2015, Class A.
Caution: Operating this product in a residential area may cause radio interference.
Attention! A license is required when exporting the Digex night vision digital riflescope outside your country.
Improvements may be made to the design of this product to enhance its user features.
The current version of the Operation Manual can be found on the website:
www.pulsar-vision.com

FR Compatibilité électromagnétique.
Ce produit est conforme aux exigences de la norme européenne EN 55032: 2015, classe A.
Attention: L'utilisation de ce produit dans une zone résidentielle peut provoquer des interférences radio.
Attention! Les viseurs numériques de vision nocturne DIGEX nécessitent l'obtention d'une licence s'ils sont exportés hors de votre pays.
La configuration peut être modifiée afin d'améliorer l'utilisation d'un appareil.
La version actuelle du manuel d'utilisation est disponible sur
www.pulsar-vision.com

DE Elektromagnetische Verträglichkeit.
Dieses Produkt entspricht den Anforderungen der Europäischen Norm EN 55032:2015, Klasse A.
Achtung: Der Betrieb dieses Produktes in Wohngebieten kann Funkstörungen verursachen.
Achtung! Digitale Nachtsichtzielfernrohre DIGEX erfordern eine Lizenz, wenn sie über die Grenzen Ihres Landes exportiert werden.
Änderungen im Design zwecks höherer Gebrauchseigenschaften des Produkts vorbehalten.
Die aktuelle Version der Bedienungsanleitung finden Sie unter
www.pulsar-vision.com

ES Compatibilidad electromagnética
Este producto cumple con los requisitos de la norma europea EN 55032:2015, Clase A.
Advertencia: el uso de este producto en una zona residencial puede provocar interferencias de radiofrecuencia.
¡Atención! La venta de visores nocturnos digitales DIGEX fuera de su país requieren una licencia de exportación.
El diseño de este producto puede ser modificado con el fin de mejorar las características del usuario.
La última edición del manual de instrucciones está disponible en el sitio web
www.pulsar-vision.com

IT Compatibilità elettromagnetica.
Questo prodotto è conforme ai requisiti della norma europea EN 55032: 2015, Classe A.
Attenzione: l'uso di questo prodotto in un'area residenziale può causare dei radiodisturbi.
Attenzione! I visori notturni digitali DIGEX necessitano di un certificato nel caso in cui vengano esportati all'estero.
Per migliorare le proprietà del prodotto nella sua costruzione possono essere apportate delle modifiche.
La versione attuale del manuale d'uso è disponibile sul sito www.pulsar-vision.com
www.pulsar-vision.com

РУ Электромагнитная совместимость.
Данный продукт соответствует требованиям европейского стандарта EN 55032:2015, Класс А.
Внимание: эксплуатация данного продукта в жилой зоне может создавать радиопомехи.
Внимание! Цифровые прицелы НВ DIGEX требуют лицензии, если они экспортируются за пределы Вашей страны.
Для улучшения потребительских свойств изделия в его конструкцию могут вноситься усовершенствования.
Актуальную версию инструкции по эксплуатации Вы можете найти на сайте
www.pulsar-vision.com

USER MANUAL FOR DIGEX NIGHT VISION DIGITAL RIFLESCOPE	3-13	ENGLISH
MANUEL DUTILISATION'EMPLOI DU VISEUR NUMERIQUE DE VISION NOCTURNE DIGEX	14-25	FRANÇAIS
BETRIEBSANLEITUNG FÜR DAS DIGITALE NACHTSICHTZIELFERNROHR DIGEX	26-37	DEUTSCH
MANUAL DE INSTRUCCIONES DEL VISOR NOCTURNO DIGITAL DIGEX	36-49	ESPAÑOL
ISTRUZIONI PER L'USO DEL VISORE NOTTURNO DIGITALE DIGEX	50-60	ITALIANO
ИНСТРУКЦИЯ ПО ЭКСПЛУАТАЦИИ ЦИФРОВОГО ПРИЦЕЛА НВ DIGEX	61-72	РУССКИЙ



⚡ TECHNICAL SPECIFICATIONS

DIGEX MODEL	Digex N450	Digex N455
SKU	76641	76642
Optical specifications:		
Lens focus, mm	50	
Focal ratio, D/f'	1:1.2	
Magnification, x	4-16 (digital zoom)	
Field of view, °, horizontal (4x magnification)	6.5	
Field of view, m@100m (4x magnification)	11.4	
Eye relief, mm	50	
Close-up range, m / y	5 / 5.47	
Diopter adjustment, D	-3/+5	
Detection distance of an animal 1.7m high, m / y	550 / 601.49	500 / 546.81
Aiming reticle		
Minute of angle click, horizontal/vertical, mm@100m	10	
Aiming reticle range, horizontal/vertical, mm at 100m	2000 (± 100 clicks)	
Electronic characteristics:		
Sensor type/resolution	HD CMOS/1280x720	
Display type/resolution	AMOLED/1024x768	
Video recorder		
Video/photo resolution, pixel	1024x768	
Video recording/photo format	.mp4 / .jpg	
Built-in memory	16 GB	
Wi-Fi channel		
Frequency	2.4 GHz	
Standard	802.11b/g	
Operating features		
Tube diameter (for mounting rings), mm	30	
Battery operating time (built-in APS3 and removable APS2) at t = 22 °C, h (Wi-Fi off)	5.5	
Power supply, V	3.0-4.2	
	Li-Ion Battery Pack	
Battery type / capacity / rated output voltage	APS2 / 2000mAh / DC 3.7V (removable) APS3 / 3200mAh / DC 3.7V (built-in)	
External power supply	MicroUSB type B (5V)	
Maximum recoil power on rifled weapons, Joules	6000	
Maximum recoil power on smooth-bore weapons, caliber	12	
Degree of protection, IP code (IEC60529)	IPX7	
Operating temperature	-25°C - +50°C (-13 °F - +122 °F)	
Dimensions (LxHxW), mm / inch	378x78x78 / 14.88x3.07x3.07	

Weight (with batteries, without IR illuminator), kg / oz	0.95 / 33.51	
Detachable IR illuminator		
	Digex X850	Digex X940
SKU	79077	79078
Type	LED	
Wavelength, nm	850	940
Lens diameter, mm	26	
Optical power of the IR illuminator, mW	Up to 300	Up to 250
Power supply, V	3 - 4.2	
Average operating time, h	7	
Operating temperature range	-25 °C - +50 °C (-13 °F - +122 °F)	
Riflescope compatibility	Digex	
Dimensions (LxHxW), mm / inch	129x84x75 / 5.08x3.31x2.95	
Weight (with battery), kg/oz	0.14 / 4.94	

⚡ PACKAGE CONTENTS

- Digex night vision digital riflescope
- APS2 battery pack (3 pcs.)
- APS battery charger
- Mains charger
- USB cable
- IR illuminator
- Allen wrench
- Carrying case
- Lens-cleaning cloth
- Quick User Manual
- Warranty card
- APS3 battery cover

⚡ DESCRIPTION

Digex night vision digital riflescopes are designed for use with hunting weapons both at night and in the daytime. In low light conditions (no light from stars and the moon) it is recommended to use an infrared illuminator with a wavelength of 850 nm or 940 nm.

Areas of application of the riflescopes are as follows: hunting, observation and orientation under conditions of limited visibility.

⚡ DISTINCTIVE FEATURES

- High range detection
- High resolution imaging
- SumLight program algorithm for additional sensitivity improvement
- Heavy caliber shock resistance: 12-gauge, 9.3x64, .375H&H
- Mounting with standard 30mm rings
- Instant start
- Strong metal housing
- Completely waterproof IPX7
- Customizable reticles

- HD AMOLED color display
- Photo and video with sound recording
- Picture in Picture function
- Stream Vision App support
- Advanced features (enabled by future riflescope software updates using free Stream Vision App)
- User-friendly controls
- B-Pack mini combined power system
- Functional and ergonomic design
- Wide operating temperature range (-25 °C - +50°C)

⚡ USEFUL FUNCTIONS AND MODES

- User-friendly interface
- Stadiametric rangefinder (to estimate distance to object)
- Built-in 3-axis accelerometer gyroscope (slope angle indication)
- Smooth digital zoom
- Large selection of electronic reticles
- Scalable reticles (reticle graduation changes proportional to zoom)
- 5 zeroing profiles (10 distances per profile)
- One-shot zero function
- Precise "Zoom Zeroing" (reducing the minute of angle click value when zeroing at high magnification)
- "Freeze Zeroing" function
- Display off function
- Wi-Fi. Remote control and observation with a smartphone

VIDEO RECORDING

- Built-in photo and video recorder with sound recording
- 16GB internal memory
- Integration with iOS and Android devices.
- Youtube. Live video streaming and recording to the Internet via smartphone and using the free Stream Vision App

BATTERY PACK

- Built-in 3200mAh battery pack APS3
- Quick change Li-Ion batteries APS2/APS3
- Built-in and external batteries APS2/APS3 can be charged via micro USB

⚡ COMPONENTS AND CONTROLS COMPONENTS AND CONTROLS

- | | |
|-------------------------------------|-------------------------------|
| 1. Eyecup | 7. Battery compartment cover |
| 2. Eyepiece diopter adjustment ring | 8. Battery APS2 |
| 3. ON button | 9. MicroUSB cover |
| 4. REC button | 10. MicroUSB port |
| 5. ZOOM button | 11. Objective lens focus ring |
| 6. Controller | 12. Lens cap |

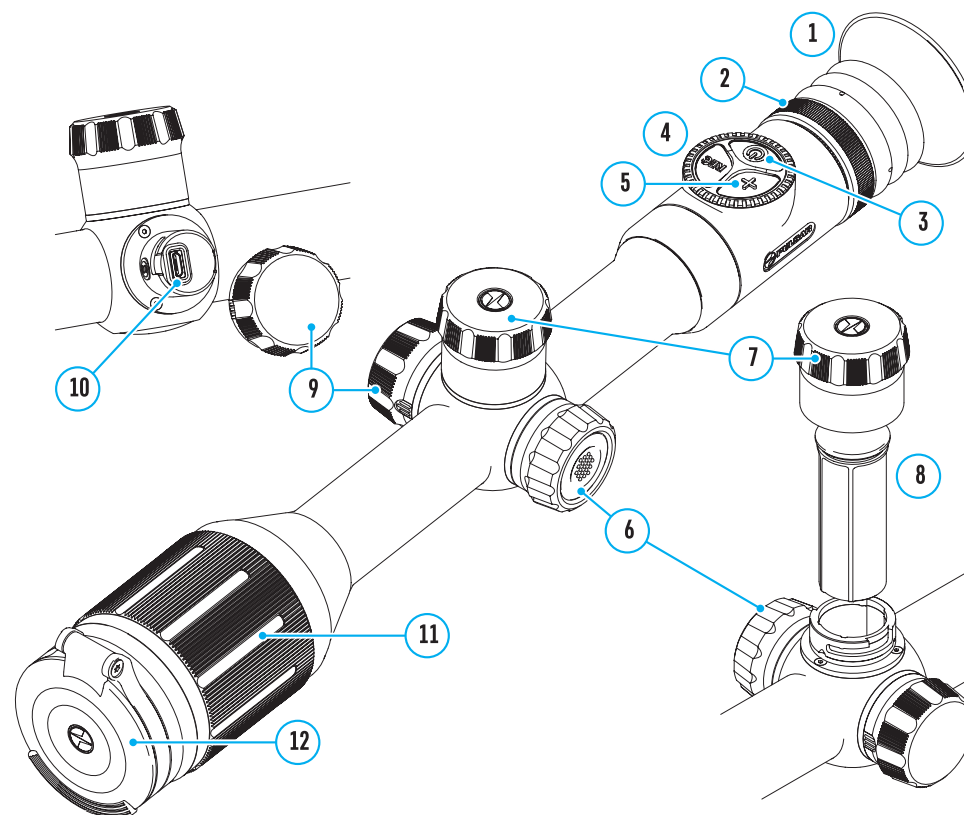

Buttons operation

Control	Condition/operating mode	First short press	Subsequent short presses	Long press	Rotation
ON button	Device is switched off	Powers on device	Enables the SumLight function	Powers on device	-
	Display off	Turns on display	Enables the SumLight function	Turns device off	-
	Device is switched on, quick menu, main menu	Enables the SumLight function	Turns off the SumLight function	Turns display off / turns device off	-
ZOOM button	Device is switched on, quick menu, main menu	Changes magnification (zoom)		Turns PiP on/off	-
REC button	Device is switched on, quick menu, main menu, video mode	Starts video recording	Pause	Switches video/photo modes	-
	Device is switched on, quick menu, main menu, video recording activated	Pause	Start video recording	Stop video recording	-
	Device is switched on, quick menu, main menu, photo mode	Photography		Switches video/photo modes	-
	Controller	Device is switched on	Accesses quick menu	-	Accesses main menu
	Quick menu	Upwards navigation		Exits quick menu	Parameter change
	Main menu	Confirms values, enters menu items		Exits menu items, main menu	Navigation through menu
	Zoom	-		-	Smooth Zooming

USING BATTERY PACK

DIGEX night vision digital riflescopes come with a built-in rechargeable Lithium-Ion APS3 battery pack with a capacity of 3200mAh and a removable rechargeable Lithium-Ion APS2 battery pack with a capacity of 2000mAh. Batteries should be charged before using.

Charging battery pack:

- Open the MicroUSB cover (9) by turning it counterclockwise.
- Connect the MicroUSB plug of the USB cable (16) to the MicroUSB port (10) in the body of the sight.
- Connect the second USB plug of the USB cable (16) to the MicroUSB port on the mains adapter (17). Plug the device into a 100-240V socket (18).

Attention! When charging batteries via the MicroUSB port (10), the built-in APS3 battery pack is charged first. When it is completely charged, the removable APS2 battery pack starts charging. When the device is in use, power consumption occurs in the reverse sequence.

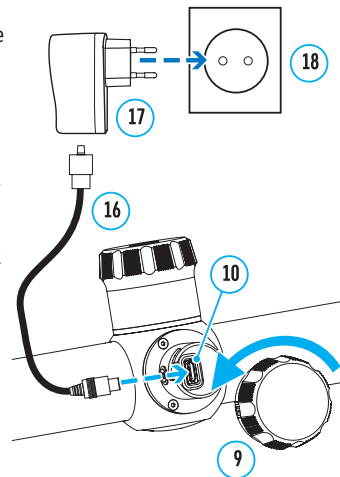

The rechargeable Lithium-Ion APS2 battery pack can be recharged using the APS charger*.

- Insert the APS2** battery pack (8) along the rail into the APS charger slot as far as it will go. The APS charger is supplied with your device.
- Point A on the battery and point B on the charger should be aligned.
- Two batteries can be charged at the same time: the second slot is designed for this.
- Connect the MicroUSB plug of the USB cable (16) to the port (14) of the charger (13).
- Connect the second plug of the USB cable (16) to the USB port on the mains adapter (17). Plug the device into a 100-240V socket (18).
- The LED indicator (15) will display battery charge level (see the table).
- Supplied as part of package.

* APS3 batteries sold separately.

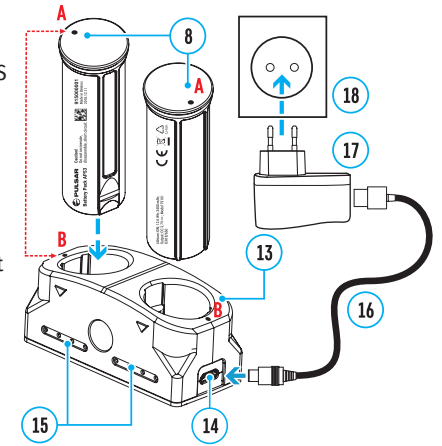

LED Indicator*	Battery charge status
•	Battery level is from 0% to 10%. Charger is not connected to the mains.
☀	Battery level is from 0% to 10%. Charger is connected to the mains.
•••••	Defective battery. Do not use.
•	Battery level is from 10% to 20%.
••	Battery level is from 20% to 60%.
•••	Battery level is from 60% to 95%.
•••••	The battery is completely charged and can be disconnected from the charger.

* LED indicator displays the current battery charge status for 30 seconds when the APS charger is not plugged in. When power is being supplied, the indicator is constantly displaying the current battery charge status, the LEDs are additionally flickering to display the battery charging process.

INSTALLING THE BATTERY PACK IN THE RIFLESCOPE

- Turn the battery cover (7) counterclockwise and remove it.
- Install the battery (8) into the battery compartment using the special guides in the device body designed for it.
- When properly installed, the battery is fixed in the battery compartment of the device.
- Close the battery compartment cover (7), turning it clockwise.

PRECAUTIONS

- When charging, always use the charger supplied with the scope. The use of any other charger may permanently damage the battery pack or the charger.
- After being stored for a long time, the battery should be partially charged: it should not be completely charged or completely discharged.
- Do not charge the battery immediately after bringing it from cold to warm. Wait for 30-40 minutes so that the battery may warm up.
- Do not leave the battery unattended while charging.

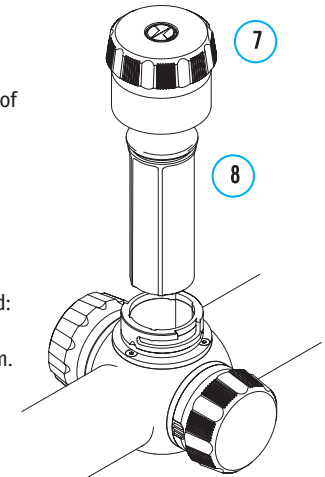

- Do not use the charger if it has been modified or damaged.
- The battery should be charged at an air temperature of 0 °C - + 45 °C or the lifespan of the battery will decrease significantly.
- Do not leave the charger with the battery connected to the mains for more than 24 hours after it has been completely charged.
- Do not expose the battery to high temperatures or naked flames.
- Do not submerge the battery.
- Do not connect an external device with a current consumption that exceeds permitted levels.
- The battery has short-circuit protection. However, all situations that may cause short-circuiting should be avoided.
- Do not disassemble or deform the battery.
- Do not drop or strike the battery.
- When using the battery at low temperatures, the battery capacity decreases, this is normal and not a defect.
- Do not use the battery at the temperatures above those shown in the table, this may decrease battery life.
- Keep the battery out of the reach of children.

SWITCHING AND CHANGING THE BATTERIES

Digex riflescopes are powered by 2 batteries: a built-in APS3 battery pack and a removable APS2 or APS3 battery pack.

- If there are two batteries in the device, two battery icons are displayed in the status bar (1 - built-in battery, 2 - removable battery). The battery from which the device is powered is displayed in blue, with the inactive battery displayed in grey. 
- If there is no removable battery in the device, only one blue icon for the internal battery is displayed in the status bar.
- When both batteries are fully charged, the device is powered by the removable battery. If the removable battery level is low, the device will switch to the built-in battery.
- When charging the batteries using the MicroUSB port (10), the built-in battery is charged first. When the built-in battery charge level reaches 100%, the device switches to charging the removable battery. The battery level is displayed in percentages above the icons in the status bar.
- It is possible to replace the removable battery with the device turned off or if turned on when being powered by the built-in battery (the device will continue to work properly).

Attention! When removing the removable battery from the device powered by it, the device will reboot and switch to operation from the built-in battery. The device will automatically switch to the removable battery if it has sufficient charge after installation.

EXTERNAL POWER SUPPLY

- Power can be supplied from an external source, such as a power bank (5V).
- Connect the external power supply to the MicroUSB port (10) of the riflescope.
- The riflescope switches to the external power source, while the built-in APS3 battery pack and the removable APS2/APS3* battery pack will gradually recharge.
- A rechargeable battery icon  indicating the percentage of battery life will appear in the status bar.
- When you turn off the external power source, the riflescope switches over to the removable battery without turning off. When there is no removable battery or it has a low power level the device switches to the built-in battery.

*Optional.

OPERATION

Attention! It is forbidden to point the riflescope lens at intensive energy sources, such as laser radiation emitting devices or the sun. It can damage the riflescopes electronic components. Warranty does not cover damage arising from failure to comply with the operating rules.

MOUNTING ON THE WEAPON

To ensure accurate shooting the Digex riflescope should be properly mounted on the weapon.

- The riflescope is fixed using mounts purchased separately. Use only high-quality mounts and rings that are designed especially for your weapon. Follow the mounting manufacturer's recommendations on the installation procedure and use the correct tools.
- When mounting the riflescope, adjust its position to enable the correct and comfortable holding of the weapon while maintaining the eye relief (the distance between the riflescope and eye) specified by the technical specifications (see the table for technical specifications). Failure to comply may result in injury to the shooter caused by the riflescope eyepiece when shooting.
- It is recommended to install the riflescope as low as possible. However, it should not be in contact with the barrel or receiver.
- In order to avoid pinching the riflescope body, a tightening torque for the screws of the mounting rings must not exceed 2.5Nm. A torque wrench is recommended to control the tightening torque.
- Before using the riflescope for hunting, follow the instructions in the Zeroing section.
- It is recommended to use an eyecup while using the riflescope in the dark in reduce light spillage from the eyepiece. Mounting the eyecup on the riflescope eyepiece is enabled using built-in magnets.

IR ILLUMINATOR

The riflescope is equipped with a built-in IR illuminator featuring a wavelength of 940nm or 850nm, which provides a significant increase in observation ranges in lowlight conditions and darkness.

INSTALLING BATTERY PACK IN THE IR ILLUMINATOR

The IR illuminator for the Digex riflescope is powered by an APS2 battery pack.

- To install the battery in the IR illuminator, turn the battery cover (21) counterclockwise and remove it.
- Install the battery into the battery compartment (20) using the special guides in the IR illuminator body designed for it.
- When properly installed, the battery is fixed in the battery compartment (20).
- Close the battery compartment (19), turning the cover clockwise.

INSTALLING THE IR ILLUMINATOR ON RIFLESCOPE

- Open the mount ring of the IR illuminator (24).
- Put the mount on the riflescope body so that the mount half rings encircle the riflescope body.
- Raising the eccentric lever (26), move it to the left. Align the eccentric axis with the groove of the moving half ring. The eccentric lever (26) shall take its seat.
- Lock the eccentric lever (26) position by lowering it down.
- The IR illuminator mount should be as close as possible to body of the riflescope lens.
- Tighten the screw in the eccentric pin (25) using an Allen wrench.
- If the lever loosens during operation, tighten the screw with an Allen key.

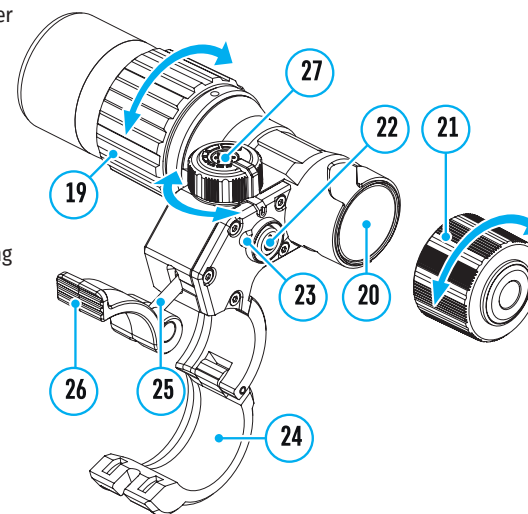

POWERING ON AND ADJUSTING THE IR ILLUMINATOR

Use the IR illuminator to improve the quality of observation in lowlight conditions at night.

- Turn on the IR illuminator by pressing the button **(22)** on the side of the light housing.
- Turn the knob **(27)** of the IR illuminator to control the illuminator power.
- To adjust the IR light position in the riflescopes field of view, loosen the ring **(19)** of the IR illuminator by turning it in the direction of the arrow.
- Adjust the IR illuminator lens using its hinge system to align the IR illumination in the riflescopes field of view. Once adjusted, tighten the IR illuminator ring **(19)**.
- Press the IR button **(22)** to turn off the IR illuminator.

The illuminator is equipped with an LED indicator **(23)** making it possible to monitor the battery level. Indication modes are in the table below:





IR Operating Mode	Indicator color
The light is on, power supply 3.2-4.2V	●
The light is on, power supply less than 3.2V. Approximate operating time before the IR illuminator turns off is 30 minutes	●
Light off	-

POWERING ON AND IMAGE SETTING

- Open the lens cap **(12)**.
- Press the ON button **(3)** briefly to power the riflescope on.
- Adjust the resolution of the symbols on the display by rotating the diopter adjustment ring of the eyepiece **(2)**.
- Rotate the lens focus ring **(11)** to focus on the object being observed.
- Adjust the brightness, contrast of the display using the controller **(6)** (for more details, see the Quick Access Menu Functions section).
- After use, turn off the riflescope by long pressing the ON button **(3)**.

ZEROING

The riflescope features two zeroing methods – one shot zeroing and using Freeze function. Zeroing is recommended to be done at the temperature close to the riflescope operating temperature.

- Mount the weapon with the riflescope installed on a bench rest.
- Set a target at a certain distance.
- Adjust the riflescope according to the recommendations in Powering On and Image Setting section.
- Select the zeroing profile (see Zeroing Profile  main menu item)
- Point the weapon at the center of the target and shoot.
- If the impact point does not match the aiming point (center of the riflescope's reticle), press and hold down the controller button **(6)** to enter the main menu.
- Rotate the controller ring (6) to select the Zeroing submenu . To confirm the selection, briefly press the controller button **(6)**.
- Set the zeroing distance value (see Zeroing menu item =>Add New Distance submenu ).
- Confirm the selected zeroing distance value by long pressing the controller button **(6)**.
- The Zeroing Parameters Settings additional menu will appear on the screen.
- Cross hairs appear in the center of the display . The X and Y coordinates of the cross hairs are in the upper right corner.



- Rotate the controller ring **(6)** to select the icon . Press the controller button **(6)** briefly.
- Holding the reticle on the point of aim, rotate the controller ring **(6)** to move the cross hairs until the cross hairs match the point of impact. To switch direction, briefly press the controller button **(6)**.

Attention! To avoid holding the reticle on the point of aim, you can use the Freeze function – freezing the zeroing screen (refer to Zeroing menu item =>Distance submenu =>Zeroing Parameters Settings=>Freeze submenu ).

- Press the controller button **(6)** briefly to switch the cross hairs movement direction from horizontal to vertical.
- To save the new reticle position, press and hold the controller button **(6)**. The reticle is aligned with the point of impact and the submenu  exits.
- Press and hold the controller button **(6)** again to exit the zeroing settings menu - the message “Zeroing coordinates saved” appears, confirming the successful operation.
- Fire a second shot - now the point of impact and the aiming point must be matched.

SMART RETICLE FUNCTION*

When changing the digital magnification of the riflescope, the reticle that appears on the display is scaled, i.e. it will change (increase or decrease) its form proportionally to the magnification, allowing the use of rangefinder reticles at any digital magnification.





*Only for scalable reticles X51Fi-300, M56Fi, M57Fi

DISCRETE DIGITAL ZOOM

- The riflescope functionality allows you to quickly magnify 2 and 4 times the standard magnification, as well as return back.
- Successively press the ZOOM **(5)** button to change the riflescope magnification.
- While the icon  is visible on the screen, rotate the controller ring (6) for smooth digital zooming of the specified magnification.

QUICK ACCESS MENU FUNCTIONS

The basic settings (adjusting brightness and contrast, smooth digital zoom function, stadiametric rangefinder, current profile and distance information) can be changed using the quick access menu.

- Press the controller button **(6)** briefly to enter the quick menu.
- A short press of the controller button **(6)** enables you to switch between functions, as described below.
- Brightness  – rotate the controller ring **(6)** to change the display brightness value from 00 to 20.
- Contrast  – rotate the controller ring **(6)** to change the image contrast value from 00 to 20.
- A100  - information on the current profile and zeroing distance in this profile (e.g., profile A, zeroing distance of 100 m). This information is always displayed in the status bar. Rotate the controller ring **(6)** to switch between the zeroing distances in the adjusted profile. This function is available if there are two or more distances in the profile.
- Stadiametric Rangefinder  – rotating the controller ring **(6)**, change the distance between the special mark points to determine the distance to the observed object (for more details on the rangefinder, see the Stadiametric Rangefinder section).
- Press and hold the controller button **(6)** to exit the menu or wait 10 seconds to exit automatically.

MAIN MENU FUNCTIONS

- Enter the main menu with a long press of the controller button **(6)**.
- To move through the main menu items, rotate the controller ring **(6)**.
- Main menu navigation is cyclical: when the last menu item of the first tab is reached, the first menu item of

the second tab comes next.

- Press the controller button **(6)** briefly to open subitems of the main menu.
- Press and hold the controller button **(6)** to exit from a subitem of the main menu.
- Automatic exit from the main menu occurs after 10 seconds of inactivity.
- After exiting the main menu the cursor location (▶) is stored only for a single working session (i.e. until the riflescope is turned off). When restarting the riflescope and entering the menu the cursor will be on the first menu item.

GENERAL VIEW OF MENU

Tab 1

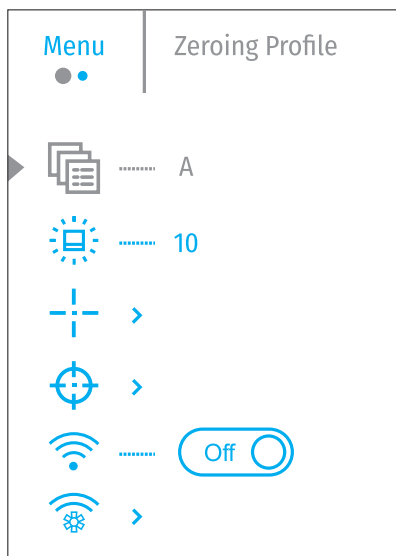

Tab 2

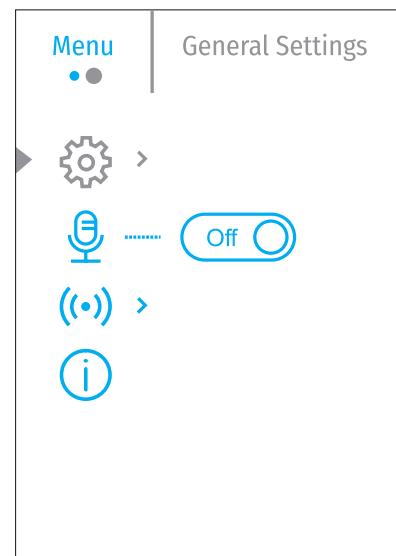

MAIN MENU CONTENTS AND DESCRIPTION

Zeroing Profile This main menu item allows you to select one of five profiles (A, B, C, D, E) to use. Each profile includes the following parameters:



- A set of zeroed distances
- Reticle color
- Reticle type

Different profiles can be used when using the riflescope on different weapons or when shooting with different ammunition.

- Press and hold the controller button **(6)** to enter the main menu.
- Rotate the controller ring **(6)** to select the Zeroing Profile menu item.
- Press the controller button **(6)** briefly to enter the Zeroing Profile submenu.
- Rotate the controller ring **(6)** to select one of the zeroing profiles (marked with the letters A, B, C, D, E).
- Confirm your selection with a short press of the controller button **(6)**.
- The name of the selected profile appears in the status bar at the bottom of the display.

Icon Brightness Adjust the brightness level of the icons and screensavers (Pulsar, Display off) on the display.



- Press and hold the controller button **(6)** to enter the main menu.
- Rotate the controller ring **(6)** to select the Icon Brightness menu item.
- Press the controller button **(6)** briefly to enter the Icon Brightness submenu.
- Rotate the controller ring **(6)** to set the desired brightness level (1 to 10).
- Press the controller button **(6)** briefly to confirm the selection.

Reticle Setup This main menu item allows you to select the reticle shape, color and brightness.



- Press and hold the controller button **(6)** to enter the main menu.
- Rotate the controller ring **(6)** to select the Reticle Setup menu item.
- Press the controller button **(6)** briefly to enter the Reticle Setup submenu.

Reticle Type Selection of the aiming reticle shape.



- Rotate the controller ring **(6)** to select the Reticle Type submenu.
- Press the controller button **(6)** briefly to enter the Reticle Type submenu.
- Rotate the controller ring **(6)** to select the desired aiming reticle shape from the list that appears. The reticle type changes as the cursor goes down the reticle list.
- Press the controller button **(6)** briefly to confirm the selection.

Reticle Color Selection of reticle color.























- Rotate the controller ring **(6)** to select the Reticle Color submenu.
- Press the controller button **(6)** briefly to enter the Reticle Color submenu.
- Rotate the controller ring **(6)** to select one of the color options for the reticle:
 - Black/Red
 - White/Red
 - Black/Green
 - White/Green
 - Red
 - Green
 - Yellow
 - Blue
 - Orange
- Press the controller button **(6)** briefly to confirm the selection.

Reticle Brightness Adjust the brightness level of the aiming reticle.



- Rotate the controller ring **(6)** to select the Reticle Brightness submenu.
- Press the controller button **(6)** briefly to enter the Reticle Brightness submenu.
- Rotate the controller ring **(6)** to set the desired brightness level (1 to 10).
- Press the controller button **(6)** briefly to confirm the selection.

<p>Zeroing</p>  <p>Add new distance</p> 	<p>To zero your riflescope, you need to set a zeroing distance first in the range of 1 to 910 m (995 yards).</p> <ul style="list-style-type: none"> Press and hold the controller button (6) to enter the main menu. Rotate the controller ring to select menu item  and enter by briefly pressing the controller button. Press the controller button (6) briefly to enter the Add New Distance submenu. Rotate the controller ring to select a value for each distance category. Press the controller button (6) briefly to switch between digits. Having set the desired distance, press and hold the controller button to save it. The distance you set first becomes a primary distance – shown with icon  on the right of the distance value. <p>Note: Maximum number of zeroing distances for each profile is ten.</p>
<p>Operating the distances</p>	<p>Press and hold the controller button (6) to enter the main menu.</p> <ul style="list-style-type: none"> Rotate the controller ring (6) to select the Zeroing menu item  and enter by briefly pressing the controller button (6) – the zeroed distances are displayed. The values (e.g., +7.0) shown on the right of the distance values stands for the number of clicks along the Y axis that the reticle position at other distances differs from the reticle position of the primary distance.
<p>Zeroing Parameters Settings</p> 	<ul style="list-style-type: none"> To zero at any distance again, rotate the controller ring (6) to select the required distance and briefly press the controller button (6). Enter the Zeroing submenu by briefly pressing the controller button (6) The zeroing screen, allowing changes of zeroing coordinates, will appear.
<p>Windage/Elevation Correction</p> 	<p>The Windage/Elevation additional menu item allows you to adjust the reticle position. For a detailed description of reticle adjustments, refer to the Zeroing section.</p>
<p>Magnification</p> 	<p>Magnification allows you to magnify the digital zoom of the riflescope when zeroing, reducing the minute of angle click. It improves the zeroing accuracy.</p> <ul style="list-style-type: none"> Rotate the controller ring (6) to select the Magnification submenu item and enter by briefly pressing the controller button. Rotate the controller ring (6) to select a digital magnification value of the riflescope (e.g., x4). Press the controller button (6) briefly to confirm your selection. <p>The minute of angle click when using the Zoom In function is indicated in the table of technical specifications.</p>
<p>Zeroing with FREEZE Function</p> 	<p>The feature of the function is that there is no need to constantly keep the riflescope at the point of aiming.</p> <ul style="list-style-type: none"> Rotate the controller ring (6) to move the cursor to the Freeze function. Align the reticle with the point of aiming and press the controller (6) or ON (3) button. A screenshot will be taken, an icon  will appear. Go to the additional Windage/Elevation submenu and adjust the position of the reticle (see the Zeroing section). Select the Freeze submenu item again and briefly press the controller (6) or ON (3) button - the image will “unfreeze”.

<p>Name Distance</p> 	<ul style="list-style-type: none"> Rotate the controller ring (6) to select the Name Distance submenu item and enter it by briefly pressing the controller button. Rotate the controller ring (6) to select a value for each digit. Press the controller button (6) briefly to switch between digits. Press and hold the controller button (6) to confirm the selection.
<p>Change Primary Distance</p> 	<ul style="list-style-type: none"> Select a Non-primary Distance and enter the submenu for operating the distances with a brief press of the controller button (6). Select item Change Primary Distance. Press the controller button (6) briefly. <p>Icon  next to the selected distance confirms the change of primary distance. The differences of other distances from a new standard distance along the Y axis are recalculated as per clicks.</p>
<p>Delete Distance</p> 	<ul style="list-style-type: none"> Select the distance you wish to delete and enter the submenu for operating the distances with a brief press of the controller button. Select Delete Distance item. Select Yes in the dialog box that appears to delete a distance. No – to cancel deletion. <p>Attention! If the primary distance is deleted, the first distance on the list automatically becomes the new primary distance.</p>
<p>Wi-Fi Activation</p> 	<ul style="list-style-type: none"> Press and hold the controller button (6) to enter the main menu. Rotate the controller ring (6) to select the Wi-Fi Activation menu item. To turn Wi-Fi On, briefly press the controller button (6). To turn Wi-Fi Off, briefly press the controller button (6).
<p>Wi-Fi Settings</p>  <p>Password Setup</p> 	<p>This item enables you to set up your riflescope for operation in a Wi-Fi network.</p> <p>This item enables you to set a password to access the riflescope from an external device. The password is used to connect an external device (i.e. smartphone) to the riflescope.</p> <ul style="list-style-type: none"> Press the controller button (6) to enter the Password Setup submenu. The default password (12345678) will appear on the screen. Rotate the controller ring (6) to set the desired password. Press the controller button (6) to toggle through the digits. Press and hold the controller button (6) to save the password and exit from the submenu.
<p>Access Level Setup</p> 	<p>This sub-function allows you to configure the appropriate level of access to your device made available to the Stream Vision application.</p> <p>Owner Level. A Stream Vision user has full access to all the device's functions.</p> <p>Guest Level. A Stream Vision user can only view video footage from the device in real time.</p> <ul style="list-style-type: none"> Press and hold the controller button (6) to enter the main menu. Press the controller button (6) briefly to enter the submenu. Rotate the controller ring (6) to select the access level. Press and hold the controller button (6) to confirm your selection and exit from the submenu.
<p>General Settings</p>  <p>Language Settings</p> 	<p>This menu item allows you to configure the following settings:</p> <ul style="list-style-type: none"> Press the controller button (6) briefly to enter the Language submenu . Rotate the controller ring (6) to select one of the available interface languages: English, German, Spanish, French, Italian or Russian. Confirm your selection with a short press of the controller button (6). Press and hold the controller button (6) to save your selection and exit from the submenu.

Date Setting



- Press the controller button **(6)** briefly to enter the Date submenu. The date is displayed in dd/mm/yyyy format.
- Rotate the controller ring **(6)** to select the desired year, month and date. Press the controller button **(6)** briefly to switch between digits.
- Press and hold the controller button **(6)** to save your selected date and exit from the submenu.

Time Setting



- Press the controller button **(6)** briefly to enter the Time submenu.
- Rotate the controller ring **(6)** to select the time format - 24 or AM/PM.
- Press the controller button **(6)** to proceed to the hour setting.
- Rotate the controller ring **(6)** to select the hour value.
- Press the controller button **(6)** to proceed to the minute setting.
- Rotate the controller ring **(6)** to select the minutes value.
- Press and hold the controller button **(6)** to save your selected time and exit from the submenu.

Units of Measure Selection



- Press the controller button **(6)** briefly to enter the Units of Measure submenu.
- Rotate the controller ring **(6)** to select the unit of measurement - meters or yards, press the controller button **(6)**.
- Return to submenu will happen automatically.

Default Settings



- Press the controller button **(6)** briefly to enter the Default Setting submenu .
- Rotate the controller ring **(6)** to select Yes for factory reset or No to cancel the action.
- Confirm your selection with a short press of the controller button **(6)**.
- If Yes is selected, display will show "Return default settings?" and Yes and No options. Select Yes to factory reset.
- If No option is selected: restore default settings is canceled and it will return to the submenu.
- The following settings will be returned to their defaults before being changed by the user:

Operating Mode – Video
Interface language – English
Wi-Fi – Off (default password)
Magnification – initial value
PiP – Off
Unit of Measurement - Metric
Weapon Incline – Off
Weapon Profile – A
Reticle selection from the riflescope's memory – 1

Attention! After factory reset the date and time as well as the zeroing profiles data entered by the user is saved.

Formatting the Device's Memory Card



- Press the controller button **(6)** briefly to enter the Format submenu .
 - Rotate the controller ring **(6)** to select Yes to format the device's memory card, or No to cancel the action.
 - Confirm your selection with a short press of the controller button **(6)**.
 - If Yes is selected, display will show Return default settings? and Yes and No options. Select Yes to format the memory card.
- If No is selected, formatting is cancelled and it will return to the submenu.

Turning On/Off Microphone



This item allows you to enable (or disable) the microphone for recording sound during video recording.

- Press and hold the controller button **(6)** to enter the main menu.
- Rotate the controller ring **(6)** to select the Microphone menu item.
- To turn On the microphone, briefly press the controller button **(6)**.
- To turn Off the microphone, briefly press the controller button **(6)**.

Accelerometer



This menu item includes two subitems - Auto Shutdown and Side Incline.

Auto Shutdown



This item allows you to activate the auto power off function for when the riflescope is in a non-operating position (tilt up/down angle exceeding 70°, tilt right/left angle exceeding 30°).

- Press and hold the controller button **(6)** to enter the main menu.
- Rotate the controller ring **(6)** to select the Accelerometer submenu, confirm the selection by briefly pressing the controller **(6)**.
- Rotate the controller ring **(6)** to select Auto Shutdown.
- Press the controller button **(6)** briefly to enter the submenu.
- Rotate the controller ring **(6)** to select the time period (1 min, 3 min, 5 min) after which the riflescope will automatically shut down, or select "Switch Off" if you wish to deactivate Auto Shutdown.
- Confirm your selection with a short press of the controller button **(6)**.

Note: If the auto power off function is activated, the status bar shows an icon and the selected shutdown time period as ⏸ 1 min.

Side Incline



This item allows you to turn on/off the cant (horizontal/side incline) indicator. The incline is indicated by two arrows on the right and left of the aiming reticle. Arrows show the direction in which you should move your rifle to eliminate the cant.

There are three measures of incline:

5°-10 ° – one sector arrow;



10°-20 ° - two sector arrow;



Over 20° - three sector arrow (see figure).

A side incline of less than 5° is not displayed.

- Press and hold the controller button **(6)** to enter the main menu.
- Rotate the controller ring to select the Accelerometer menu item.
- Press the controller button **(6)** briefly to enter the Accelerometer submenu.
- Rotate the controller ring to select Side Incline
- Press the controller button **(6)** briefly to enter the Side Incline submenu.
- Rotate controller ring to select On to turn on the cant indication or Off to turn it off.
- Confirm your selection with a short press of the controller button **(6)**.

Device Information



- Press and hold the controller button **(6)** to enter the main menu.
- Rotate the controller ring **(6)** to select the Device Information menu item.
- Press the controller button **(6)** briefly to enter the Device Information submenu.

This item allows the user to view the following information about the riflescope:

- Full name of the riflescope.
- SKU number.
- Serial number of the riflescope.
- Riflescope software version.
- Hardware version.
- Service information.
- Battery information.

STATUS BAR



The status bar is at the bottom of the display and shows information on the actual operating status of the riflescope, including:

- Actual zeroing profile (e.g., A).
- Zeroing distance (e.g., 100 m).
- SumLight (on/off).
- Current compound magnification.
- Microphone (on or off).
- Wi-Fi connection.
- Auto power off function (e.g., 5 minutes).
- Clock.
- Battery discharge level (when riflescope is powered by a built-in or removable battery), or
- External battery power indicator (if the riflescope is powered by an external power supply), or
- Battery indicator with current percentage of charge (when charging from an external power source).

VIDEO RECORDING AND PHOTOGRAPHY

The riflescope is equipped with a video recording (photography) function where the observed image is saved on the built-in memory card.

Before using the photo and video functions, read the Date Setting and Time Setting subsections of the Main Menu Functions section of this manual.

Built-in recorder operates in two modes:

Photo (photography; the icon is displayed in the upper left corner of the display).

Video (video recording; the icon is displayed in the upper right corner of the display, the total remaining recording time is given taking into account the current resolution in the HH:MM format (hours:minutes).

When switched on, the riflescope is in the Video mode. Toggle (switch) between the riflescope operating modes with a long press of the REC **(4)** button. Switching between the modes is cyclical (Video-> Photo-> Video).

Photo Mode. Photographing an image.

- Switch to Photo mode.
- Press the REC button **(4)** briefly to take a photo. The image freezes for 0.5 sec - a photo is saved to the internal memory.

Video Mode. Recording a video.

- Switch to the Video mode with a long press of the REC **(4)** button.
- Press the REC **(4)** button briefly to start video recording.
- When the video recording starts, the icon will disappear and the REC icon as well as the video recording timer displayed in MM:SS (minutes:seconds) format will appear.
- Pause/continue recording by briefly pressing the REC button **(4)**.
- Press and hold the REC **(4)** button to stop video recording.

Video files are saved to the built-in memory card in the following cases:

after turning off the video recording/photography;

if powering the riflescope off when recording was on;

when the memory card is overfilled during recording (Memory Full message appears on the display);

when connecting the riflescope in the Memory Card mode to the computer.

Notes:

You can enter and navigate the menu during video recording.

Recorded videos and photos are saved to the built-in memory card of the riflescope in the format img_XXX.jpg (for photos); video_XXX.mp4 (for video) where XXX is a three-digit counter (for videos and photos).

The maximum duration of a recorded video file is five minutes. After this time expires, the video is recorded to a new file. The number of recorded files is limited by the capacity of the unit's internal memory.

Regularly check free memory within the built-in memory card and move the footage to other storage media to free up the memory card space.

WI-FI FUNCTION

The riflescope has a function enabling wireless communication with mobile devices (smartphone or tablet) via Wi-Fi.

- To enable the wireless module, enter the main menu by long pressing the controller button **(6)**.
- Rotate the controller ring **(6)** to select the Wi-Fi Activation menu item.
- Press the controller button **(6)** briefly to turn the Wi-Fi module on/off.

Wi-Fi is displayed in the status bar as follows:

Wi-Fi is switched off	
Wi-Fi is switched on by the user, Wi-Fi connection in the riflescope is in progress.	
Wi-Fi is switched on, there is no connection to the riflescope	
Wi-Fi is switched on, there is connection to the riflescope	

- The riflescope is recognized by an external device under the name Digex_XXXX, where XXXX are the four last digits of the serial number.
- After entering the password (default: 12345678) on a mobile (see Wi-Fi Setup section of the Main Menu Functions section of this manual for more information on setting a password) and setting up a connection, the icon in the riflescope status bar changes to .
- Launch Stream Vision application on your mobile device (see page 21 of the manual).
- Video broadcasting on a mobile screen starts after the viewfinder button on the mobile screen is activated.

⚡ STADIAMETRIC RANGEFINDER

The Digex night vision digital riflescope is equipped with a stadiametric rangefinder, allowing you to determine the approximate distance to an object if its size is known.

- To select the Stadiametric Rangefinder function, enter the quick access menu by briefly pressing the controller button **(6)**.
- Press the controller button **(6)** briefly to select the icon .
- The display will show the lines for measurements, the icons and numbers of the measured distance for three objects.

There are three predefined values for objects:

Hare – 0.3 m high

Boar – 0.7 m high

Deer – 1.7 m high

- Place the bottom fixed line under the object and rotating the controller ring **(6)**, move the upper line relative to the lower horizontal fixed line so that the object is located directly between the lines. The objects range is automatically recalculated as the line is moved.
- The system will exit from the Stadiametric Rangefinder function automatically if there is no measurement within 10 seconds.
- To select a unit of measurement (meters or yards), go to the General Settings menu item =>Units of Measure submenu.
- The measured range value is rounded off before being displayed – for large range values up to 5 m, for shorter range – up to 1 m.
- To exit the rangefinder mode, briefly press the controller button **(6)** or wait 10 seconds to exit automatically.

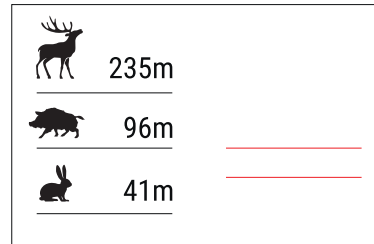

⚡ DISPLAY OFF FUNCTION

When this function is in use, the riflescope switches to the standby mode, which allows it to be switched on quickly if necessary.

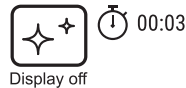

Options for operating with the Display Off function

Option 1. Riflescope off. It is necessary to power the riflescope on and activate the Display Off function.

- Press the ON button **(3)** briefly to power the riflescope on.
- Activate the Display Off function: press and hold the ON button **(3)**. The Display Off message with a countdown will appear on the screen.
- Release the ON **(3)** button.
- Press the ON **(3)** button briefly to deactivate the Display Off function (to activate the display).

Option 2. The Display Off function is activated; the riflescope should be switched off.

- Press and hold the ON **(3)** button. Display Off message with 3, 2, 1 countdown will appear on the screen.
- Hold ON **(3)** button until the riflescope turns off (the riflescope turns off after counting down past 1).

⚡ PIP FUNCTION

The PiP function (Picture-in-Picture) allows you to see both a magnified image in a special dialog box and the main image.

- Press and hold the ZOOM button **(5)** to turn on/off the PiP function.
- To change digital magnification in the PiP dialog box, rotate the controller ring **(6)**, while the icon is visible on the screen.
- The magnified image is displayed in a special dialog box, with the full magnification being used.

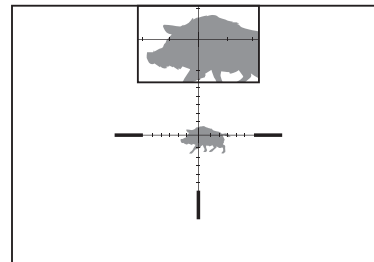

- The rest of the image is displayed only with the optical magnification (digital magnification is off).
- When PiP is turned off, the display shows the full magnification set for the PiP mode.

⚡ STREAM VISION

Digex night vision digital riflescopes support Stream Vision technology, which allows you to stream an image from the display of your riflescope to a smartphone or a tablet PC via Wi-Fi in real time.

You can find detailed instructions on Stream Vision in the separate brochure or at the website www.pulsar-vision.com.

Note: Software updates are provided for the riflescope. Updating is made possible via the Stream Vision application.

To download the Stream Vision application scan the QR codes or follow the links:



USB CONNECTION

- Press the ON button **(3)** briefly to power the riflescope on (the computer will not detect the riflescope if it is turned off).
- Connect one end of the USB cable to the riflescope MicroUSB port **(10)**, and the other one to the port on your computer.
- The riflescope is detected by the computer automatically and no installation of drivers is required.
- After a few seconds, two connection options appear on the display:
- Power and Memory Card.
- Rotate the controller ring **(6)** to select the connection option.
- Press the controller button **(6)** briefly to confirm your selection.

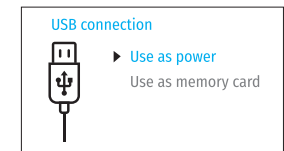

Connection options

Power. Upon choosing this mode, your PC is used as an external power supply. The icon  appears in the status bar. The riflescope continues operating and all functions are accessible.

The battery pack installed in the riflescope is not charged.

Memory card. Upon choosing this mode, the computer detects the riflescope as a flash card. This mode is designed to manage the files saved in the riflescope's memory. The riflescope's functions are not available in this mode; the riflescope turns on. The device continues to operate after being disconnected from the computer.

If a video was being recorded at the moment of connection, the recording will stop and will be saved.

USB disconnection

- When the USB is disconnected from the riflescope in the Power mode, the riflescope stays on powered by battery pack if it is sufficiently charged.
- When the USB is disconnected from the riflescope in the Memory Card mode, the riflescope remains switched on.

⚡ MAINTENANCE

Maintenance should be carried out at least twice a year and includes the following steps:

- Wipe the exterior metal and plastic parts with a cotton cloth to remove dust and dirt. Silicone grease may be used for this.
- Clean the electric contacts of the battery pack and battery slots on the riflescope using a non-greasy organic solvent.
- Check the optics of the eyepiece and the lens. If necessary, remove dust and dirt from the optics (preferably using a non-contact method). Cleaning of the exterior surfaces of the optics should be done with products designed specially for this purpose.

⚡ TROUBLESHOOTING

The table shows a list of problems that may occur when using the riflescope. Carry out the recommended checks and troubleshooting steps in the order listed in the table. If there are defects that are not listed below, or it is impossible to repair the defect yourself, return the riflescope for repair/service.

Malfunction	Possible cause	Corrective action
Riflescope will not turn on.	The batteries are completely discharged.	Charge the battery.
Riflescope will not work from an external power source.	USB cable is damaged.	Replace USB cable.
	External power source is discharged.	Charge the external power source.
Image is too dark.	Low brightness or contrast level is set.	Adjust brightness or contrast.
Colour bars appear on the display or the image disappeared.	The device was exposed to static stress during operation.	After the exposure to static stress, the device may either reboot automatically or require switching off and on again.
Image of the aiming reticle is clear while that of the object is fuzzy.	There is dust or condensation on the interior or exterior optical surfaces of the lens.	Wipe off the outside optical surfaces with a soft cotton cloth. Let the riflescope dry by leaving it in a warm environment for 4 hours.
	The lens is not focused.	Adjust the image sharpness by rotating the objective lens focus ring.
The aiming reticle shifts after firing rounds.	The riflescope is not mounted securely or the mount is not fixed on the riflescope.	Check that the riflescope has been securely mounted. Make sure that the same type and caliber ammunition is being used as when the riflescope and weapon were initially zeroed. If you have zeroed the riflescope in summer and then use it in winter (or vice versa), a change in the zero point cannot be discounted.
The riflescope will not focus.	Incorrect setting.	Adjust the riflescope according to the Powering On and Image Setting section. Check the exterior surfaces of the lens and eyepiece; where necessary, wipe them free from dust, condensation, frost, etc. In cold weather, you can use special anti-fogging coatings (e.g., for corrective glasses).

Smartphone or tablet cannot be connected to the riflescope.	The password in the riflescope was changed.	Delete the network and connect again typing the password saved in the riflescope.
	The device is in an area with a large number of Wi-Fi networks that may cause interference.	To ensure stable Wi-Fi connection, relocate the device to an area with fewer Wi-Fi networks or to an area with none.
Missing or interrupted broadcasting via Wi-Fi.	The smartphone or tablet is out of range of strong Wi-Fi signals. There are obstacles between the device and the smartphone or tablet (e.g., concrete walls).	Relocate smartphone or tablet into the Wi-Fi signals line of sight.
Image is over-exposed.	Use the riflescope with a closed lens cover.	
There are several light or black dots (pixels) on the riflescope's display or sensor.	Presence of these pixels is caused by the peculiarities of the sensor or display production technology and is not a defect.	
Poor image quality or reduced detection distance.	These problems may occur during observation in adverse weather conditions (e.g., snow, rain, fog etc.).	

Repair of the device is possible within 5 years.











































































